

Track Tester

DC & DCC O & G Gauge OO HO N Gauge



- Quickly checks track for power faults
- Small & Larger Versions - for N gauge to G gauge!
- Multicolour LED Indicates the DC polarity, or DCC, or a fault

Buffer Lights

WIRE FREE DC & DCC O Gauge OO HO N Gauge



- Realistic stop light for any siding - fits most buffer stops
- Simply clips onto track - No wires!
- On DCC both lights are on constantly
- On DC one light is on & varies with speed

DCC Fitted Digital Signals

DCC WIRE FREE OO HO



- Signal with DCC decoder built in - No CV programming
- Easy to fit and use - can just plug direct into track - no wires!
- Wide range available - also available with Feathers and Theatres

One-Touch DCC™ Point Controllers

DCC ANY GAUGE



- Control points and uncouplers using DCC
- Work with most solenoid point motors - Built in CDU
- Just connect 2 wires to DCC rails - No CV Programming!
- Easy screw terminals - no soldering

LFX Lighting Effect Controllers

DC & DCC ANY GAUGE



- Easy way to add lighting effects to your layout
- Wires screw in - no resistors or soldering - LEDs included
- Powered by 9v battery, 8-16V DC or DCC
- On DC the effect is on when powered - On DCC it can be controlled

Level Crossing - Ready Assembled

DC & DCC OO HO N Gauge



- Power from 9-16v DC, DCC or a 9v battery - available in single & pairs
- Light and sound - all connections easy push fit
- Includes 2 x Peco static level crossing barriers
- Can be turned on automatically using a Track Sensor

Traffic Lights - Ready Assembled

DC & DCC OO HO



- Power from 9-16v DC, DCC or 9v battery - 2 Wire connection
- Realistic standard UK sequence and timing varies randomly
- Fully assembled - drill hole in baseboard & connect to power

Track Sensor

DC & DCC OO HO N Gauge



- Trigger level crossings and change semaphore signals
- Power from 12-16v smooth DC or DCC
- Can be used to trigger Sound Track, Smart Screen, Relays
- Four outputs for direct connection to LEDs for occupancy, FX

Mimic Switches & Lights

DC & DCC ANY GAUGE



- Make a mimic panel to control Layout Link items - Single wire to control
- Link to Track Sensors or Sensor Signals and LEDs show occupancy & signal status
- Link to Sensor Signals to manually override and switch route indicators on/off

Smart Lights - Easy to fit Lighting Effects

DC & DCC ANY GAUGE



- Small - Just 1cm x 1cm x 0.3cm with 2 wires
- Power by 9-16v DC, 9v battery, or direct to DCC which can control some effects
- Just connect and go - no setting up required
- Disco / Emergency / Real Fire / TV / Welding / Random / Programmable

Automatic Tail, Firebox & Loco Lights

DC & DCC AUTO WIRE FREE ANY GAUGE



- No switch - senses motion & turns on!
- Turns off automatically 4 minutes after stopping
- No pickups, wires or soldering - LED just plugs in
- Fit in brake vans, coaches, loco, wagons etc
- Runs for ages on 2032 button battery - LEDs & battery included

Sound for your layout

DC & DCC AUTO WIRE FREE ANY GAUGE



- Sound capsule with no wires - runs from a battery - built in speaker
- No connections to track so work with both DC & DCC
- Motion activated - switches on when train moves! Real Sounds!
- Tiny - 25mm x 20mm x 12mm - N gauge fitting guide available

Sound Track

- Record your own sounds and play them back on your layout!
- Record 4 tracks upto 35 seconds each - Lock to protect favourites
- Portable - use with 9v battery to take out & record sounds
- Power from DC or DCC - Use Track Sensors or DCC to trigger sounds

Scenic Sounds

- Background sounds for your layout - built in speaker & volume
- Power from DC or DCC - on DCC sounds can be triggered
- Lineside • Station Steam • Station Modern • Urban • Rural

Signal Kits

DC & DCC OO HO

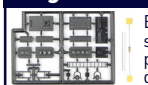

- Every kit includes the signal head, aluminium post & base plus detailing kit

- Low cost - adapt to your own design
- Control by switches or signal controller
- LEDs are prefitted to a narrow PCB
- Ground signals - modern & original
- Feather & Theatre kits available
- Signal Head only for gantries etc

LED21 - 12v LED Pack



Signal Controllers

DC & DCC AUTO ANY GAUGE

- **DCC Signal Controllers** - Wire in any LED signals to control from DCC accessory address
- **Automatic Signal Controllers** - Make any LED signal kit into an Automatic Signal!
- **Dapol Semaphore Controllers** - Control Dapol Semaphores by DCC or automatically

Automatic Sensor Signals

WIRE FREE DC & DCC OO HO



- Detects train and changes signal automatically to red
- Used own & signal changes back to green after train short time
- Or link to other Sensor Signals for fully automatic block signalling
- Can be used on both DC & DCC - Feather & Theatre versions

Automatic Coach Lighting

DC & DCC AUTO WIRE FREE OO HO N Gauge



- Easy to fit - no wiring or switch - senses motion & turns on!
- Turns off automatically - fits most coaches - may be cut down
- No pickups or wires so works on regular DC & DCC
- Traditional warm white or modern cool white
- Also with tail light, sparking, door beeps and door light effects

Servo Controller

DC & DCC ANY GAUGE



- Controls standard radio control servo from DCC, Track Sensor or Mimic switch
- Ideal for animating Level Crossing barriers / gates, Slow points or signals, Coal hopper
- Easy to wire and set up - connects directly to DCC or 8-16 volts smooth DC supply

Relay Controller

DC & DCC ANY GAUGE



- Two channel Relay unit which can be controlled by Track Sensor, Sensor Signal or DCC
- Enables remote control of motors, solenoids, lamps etc
- Incorporates two heavy duty relays with changeover contacts rated at 8-24 volts at 3 A

Automatic Train Control

DC & DCC ANY GAUGE

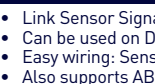

- Link Sensor Signals to Relay Controller for automatic trains which stop at red lights!
- Can be used on DC or DCC Layouts
- Easy wiring: Sensor Signal link with one wire and Isolated braking section two wires.
- Also supports ABC fitted DCC Loco's for gradual slow down and speed up with sound

Tools, LEDs & Accessories

ANY GAUGE

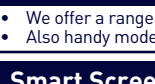

- We offer a range of LED packs, battery holders, wire, switches & terminals
- Also handy modelling tools including precision cutters, drill bits & spare batteries

Smart Screen

DC & DCC OO HO



- Real working animated screen - customise with your messages
- Use DCC to program - then can be run on DC or DCC
- Trigger messages with DCC, switches, track sensors or just cycle
- Message can change with direction of train on both DC & DCC
- Display upto 10 different messages - can also show real time clock
- Range of enclosure available - Programming service available
- Small - w 31mm x h 9.5mm x d 4.5mm
- Stationary top line - bottom line automatically scrolls

SEE WWW.TRAIN-TECH.COM OR ASK FOR FREE COLOUR BROCHURE



Train-Tech
Model Technology Made Easy

LED 21 3mm Cool White LEDs for 9-12 volts with wires - pack of 10

- Pack 10 x Cool White 3mm LEDs for 9-12 volts
- Easy to connect - 20cm wires & resistors built in
- Ideal for lighting buildings, coaches, vehicles etc

www.Train-Tech.com

See our website, your local model shop or contact us for a free colour brochure
Train-Tech, Gagemaster House, Gagemaster Way, Ford Road, Arundel, BN18 0BN
Telephone 01903 884321 • email train-tech@gagemaster.co.uk

LED 21 - Pack of 10 x Cool White 3mm LEDs for direct connection to 9 - 12 volts

CAUTION - ALWAYS SWITCH OFF POWER TO YOUR LAYOUT BEFORE CONNECTING OR DISCONNECTING ACCESSORIES

Introduction

LED 21 Contents

10 x Cool white 3mm 9-12V LEDs

This set of 10 LED lights are ideal for lighting buildings, coaches, vehicles etc and come with 20cm leads and current limiting resistors already fitted. This set is cool white, which means they produce a bright white similar to the light which comes from modern fluorescent or LED lighting.

Most LEDs can only be powered from a maximum of 2 to 3 volts DC (depending on type) and so have to have a resistor fitted in series to allow them to work on higher voltages like the 12 volts found on a model railway layout (see below). However the LEDs in this pack have a resistor wired in between one of the LED connections so that they can be powered directly from 9 to 12 volts without having to fit a resistor.

See below for more detailed information about LEDs.

Using LEDs with a DC supply

LEDs have a polarity, which means they will only light if connected the correct way onto the power supply. On these LEDs with wires fitted the black wire should be connected to the - negative supply and the red wire connected to the + positive.

Note: As these LEDs have a resistor built-in no damage will happen as a result of connecting them the wrong way round to the power supply, but they will not light.

Wiring LED to switch and power

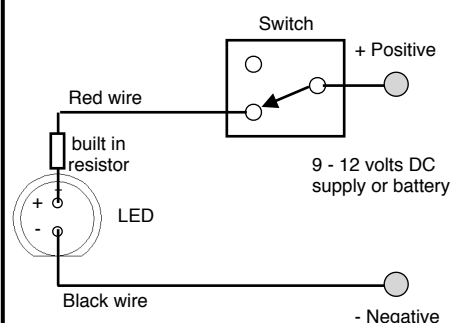

Tips on lighting with LEDs

• Traditional filament bulbs tend to spread light all around, but the LEDs in this set are quite directional, with most of the light coming out of the front of the LED. This is good for things like headlights or spot lights which need a beam, but less suitable for lighting buildings or coaches etc. If you need a more even spread of light around the LED you can diffuse the light by roughening up the clear gloss surface of the LED using emery paper or similar - it is surprisingly easy and effective!

• Another tip to help light buildings is to use reflective surfaces inside rooms etc. For example most card models of buildings have just a dark grey surface on the inside of rooms which not only looks dull but also does not spread light very well. Painting the inside walls a light colour, or gluing a paper surface like wallpaper will really enhance the light effect and make rooms more natural, especially if you use different colours (curtains too!).

General information on LEDs

LEDs are really useful lights which, unlike their conventional filament bulb counterparts, are robust, low power and if used correctly can effectively last forever. But there are important considerations to using them.

LED stands for *Light Emitting Diode* and a diode is an electronic component which only works electrically in one direction, so always need to be fitted the correct way round to work correctly and last. Whilst LED's will work on AC (alternating current or DCC which is a form of AC) for a while, continuous use on AC or reverse connection will reduce the life.

Most standard miniature LEDs which a modeller will use must only have a maximum voltage of 2 to 3 volts applied, so current flowing through the LED needs to be reduced and this is usually done by a resistor in series (in between), typically 1000 ohms for a 12 V supply. However to make wiring easier for modellers all Train-Tech LFX and Signal LED controllers already have resistors built in so that LEDs can connect directly to the module without the need for any resistors.

Train-Tech also offer packs of various LEDs for modellers and these always come with instructions and also suitable resistors for using them on a standard Model Railway 12V DC supply.

LED connections

As explained previously most LEDs have a polarity and must be connected the correct way round to light. The most popular LEDs come in 3mm and 5mm diameter cases and look similar to this:

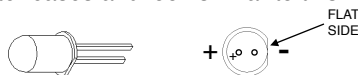

The best indication of polarity on this type of LED is to find the flat side on the round base. This side usually indicates the negative (Cathode) connection and the other wire the positive (Anode) connection to power.

Another very small LED we supply for some Train-Tech products looks like this:

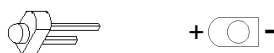

There are many LEDs on the market and it is good to experiment, but check manufacturers data for specific connection information as there are no real standards.

Remember to always use a resistor in series with the LED when using it on a standard DC power supply or battery.

Resistors

We offer the following for interest only - a modeller does not usually have to know what a component does, just when to use it. Resistors are probably the most commonly used electronic component. They offer a resistance to flow of current in a circuit by converting the 'resisted' energy into heat, though in practice you will not usually be able to detect the heat dissipated because of the small amounts of power usually involved. Every resistor has a resistance value measured in ohms, often shown as Ω or sometimes R. The resistors supplied with our LEDs are 1K Ω ; 1 kilo ohm or 1000 ohms. There are many different values of resistor and most are colour coded to indicate their value. For interest, this is the colour code system in case you ever need to identify one:

Black	0	Green	5
Brown	1	Blue	6
Red	2	Violet	7
Orange	3	Grey	8
Yellow	4	White	9

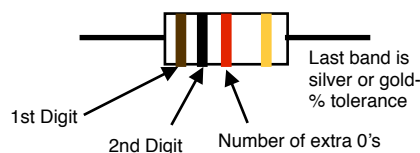

So a 1000 Ω (1k Ω) resistor is colour coded: Brown = 1; Black = 0; Red = 0 0