



Track Tester DC & DCC O & G Gauge OO HO N Gauge



- Quickly checks track for power faults
- Small & Larger Versions - for N gauge to G gauge!
- Multicolour LED Indicates the DC polarity, or DCC, or a fault

Buffer Lights WIRE FREE DC & DCC O Gauge OO HO N Gauge



- Realistic stop light for any siding - fits most buffer stops
- Simply clips onto track - No wires!
- On DCC both lights are on constantly
- On DC one light is on & varies with speed

DCC Fitted Digital Signals DCC WIRE FREE OO HO



- Signal with DCC decoder built in - No CV programming
- Easy to fit and use - can just plug direct into track - no wires!
- Wide range available - also available with Feathers and Theatres

One-Touch DCC™ Point Controllers DCC ANY GAUGE



- Control points and uncouplers using DCC
- Work with most solenoid point motors - Built in CDU
- Just connect 2 wires to DCC rails - No CV Programming!
- Easy screw terminals - no soldering

LFX Lighting Effect Controllers DC & DCC ANY GAUGE



- Easy way to add lighting effects to your layout
- Wires screw in - no resistors or soldering - LEDs included
- Powered by 9v battery, 8-16V DC or DCC
- On DC the effect is on when powered - On DCC it can be controlled

Level Crossing - Ready Assembled DC & DCC OO HO N Gauge



- Power from 9-16v DC, DCC or a 9v battery - available in single & pairs
- Light and sound - all connections easy push fit
- Includes 2 x Peco static level crossing barriers
- Can be turned on automatically using a Track Sensor

Traffic Lights - Ready Assembled DC & DCC OO HO



- Power from 9-16v DC, DCC or 9v battery - 2 Wire connection
- Realistic standard UK sequence and timing varies randomly
- Fully assembled - drill hole in baseboard & connect to power

Track Sensor DC & DCC OO HO N Gauge



- Trigger level crossings and change semaphore signals
- Power from 12-16v smooth DC or DCC
- Can be used to trigger Sound Track, Smart Screen, Relays
- Four outputs for direct connection to LEDs for occupancy, FX

Mimic Switches & Lights DC & DCC ANY GAUGE

- Make a mimic panel to control Layout Link items - Single wire to control
- Link to Track Sensors or Sensor Signals and LEDs show occupancy & signal status
- Link to Sensor Signals to manually override and switch route indicators on/off

Smart Lights - Easy to fit Lighting Effects DC & DCC ANY GAUGE



- Small - Just 1cm x 1cm x 0.3cm with 2 wires
- Power by 9-16v DC, 9v battery, or direct to DCC which can control some effects
- Just connect and go - no setting up required
- Disco / Emergency / Real Fire / TV / Welding / Random / Programmable

Automatic Tail, Firebox & Loco Lights DC & DCC AUTO WIRE FREE ANY GAUGE



- No switch - senses motion & turns on!
- Turns off automatically 4 minutes after stopping
- No pickups, wires or soldering - LED just plugs in
- Fit in brake vans, coaches, loco, wagons etc
- Runs for ages on 2032 button battery - LEDs & battery included

Sound for your layout DC & DCC AUTO WIRE FREE ANY GAUGE

SFX Sound

- Sound capsule with no wires - runs from a battery - built in speaker
- No connections to track so work with both DC & DCC
- Motion activated - switches on when train moves! Real Sounds!
- Tiny - 25mm x 20mm x 12mm - N gauge fitting guide available

Sound Track

- Record your own sounds and play them back on your layout!
- Record 4 tracks upto 35 seconds each - Lock to protect favourites
- Portable - use with 9v battery to take out & record sounds
- Power from DC or DCC - Use Track Sensors or DCC to trigger sounds

Scenic Sounds

- Background sounds for your layout - built in speaker & volume
- Power from DC or DCC - on DCC sounds can be triggered
- Lineside • Station Steam • Station Modern • Urban • Rural

Signal Kits DC & DCC OO HO

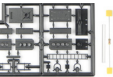

- Every kit includes the signal head, aluminium post & base plus detailing kit
- Low cost - adapt to your own design
- Control by switches or signal controller
- LEDs are prefitted to a narrow PCB
- Ground signals - modern & original
- Feather & Theatre kits available
- Signal Head only for gantries etc

LED5 - LED Pack



5 060325 130351

Signal Controllers DC & DCC AUTO ANY GAUGE

- DCC Signal Controllers** - Wire in any LED signals to control from DCC accessory address
- Automatic Signal Controllers** - Make any LED signal kit into an Automatic Signal!
- Dapol Semaphore Controllers** - Control Dapol Semaphores by DCC or automatically

Automatic Sensor Signals WIRE FREE DC & DCC OO HO



- Detects train and changes signal automatically to red
- Used own & signal changes back to green after train short time
- Or link to other Sensor Signals for fully automatic block signalling
- Can be used on both DC & DCC - Feather & Theatre versions

Automatic Coach Lighting DC & DCC AUTO WIRE FREE OO HO N Gauge



- Easy to fit - no wiring or switch - senses motion & turns on!
- Turns off automatically - fits most coaches - may be cut down
- No pickups or wires so works on regular DC & DCC
- Traditional warm white or modern cool white
- Also with tail light, sparking, door beeps and door light effects

Servo Controller DC & DCC ANY GAUGE

- Controls standard radio control servo from DCC, Track Sensor or Mimic switch
- Ideal for animating Level Crossing barriers / gates, Slow points or signals, Coal hopper
- Easy to wire and set up - connects directly to DCC or 8-16 volts smooth DC supply

Relay Controller DC & DCC ANY GAUGE

- Two channel Relay unit which can be controlled by Track Sensor, Sensor Signal or DCC
- Enables remote control of motors, solenoids, lamps etc
- Incorporates two heavy duty relays with changeover contacts rated at 8-24 volts at 3 A

Automatic Train Control DC & DCC ANY GAUGE

- Link Sensor Signals to Relay Controller for automatic trains which stop at red lights!
- Can be used on DC or DCC Layouts
- Easy wiring: Sensor Signal link with one wire and Isolated braking section two wires.
- Also supports ABC fitted DCC Loco's for gradual slow down and speed up with sound

Tools, LEDs & Accessories ANY GAUGE

- We offer a range of LED packs, battery holders, wire, switches & terminals
- Also handy modelling tools including precision cutters, drill bits & spare batteries

Smart Screen DC & DCC OO HO



- Real working animated screen - customise with your messages
- Use DCC to program - then can be run on DC or DCC
- Trigger messages with DCC, switches, track sensors or just cycle
- Message can change with direction of train on both DC & DCC
- Display upto 10 different messages - can also show real time clock
- Range of enclosure available - Programming service available
- Small - w 31mm x h 9.5mm x d 4.5mm
- Stationary top line - bottom line automatically scrolls

SEE WWW.TRAIN-TECH.COM OR ASK FOR FREE COLOUR BROCHURE



LED 5 Pack of 4 LEDs & resistors for Welding Lighting Effects

- Pack of 2 red & 2 cold-white Ultra-bright LEDs
- Use with LFX5 Welding effects controller
- Or use on DC or battery using resistors supplied

www.Train-Tech.com

See our website, your local model shop or contact us for a free colour brochure
 Train-Tech, Gagemaster House, Gagemaster Way, Ford Road, Arundel, BN18 0BN
 Telephone 01903 884321 • email train-tech@gagemaster.co.uk

LED 5 - Pack of 4 Ultra-bright LEDs for Welding Light Effects

CAUTION - ALWAYS SWITCH OFF POWER TO YOUR LAYOUT BEFORE CONNECTING OR DISCONNECTING ACCESSORIES

Introduction

LED 5 Contents

- 2 x Ultra-bright Red LEDs
- 2 x Ultra-bright Cold White LEDs
- 4 x 1K Ω resistors (brown, black, red)

This set of LEDs was primarily designed for use with the Train-Tech LFX5 Welding Light effect controller but can equally well be used for many other applications or control systems.

These instructions include basic information on connecting and using LEDs with LFX and regular DC supplies.

Using LEDs with LFX Controller

If using the LEDs in this set with an LFX LED controller please refer to the detailed instructions included with the LFX. It will show how to connect them and the maximum number you can use.

Please note that you do not need to use resistors with LEDs connected to an LFX as resistors have already been built into the controllers.

LFX controller

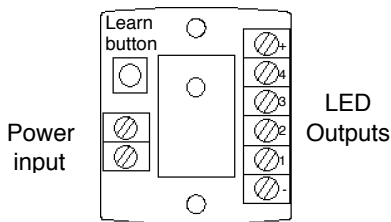

For detailed connection information see instructions supplied with the LFX

Using LEDs with a DC supply

These LEDs may be used with a standard DC power supply or battery.

If using them on a DC supply it is very important to connect a resistor in series (in between) the LED and the power supply or permanent damage to the LED will result.

This pack includes a 1K Ω resistor for every LED supplied.

Wiring LED, switch and resistor

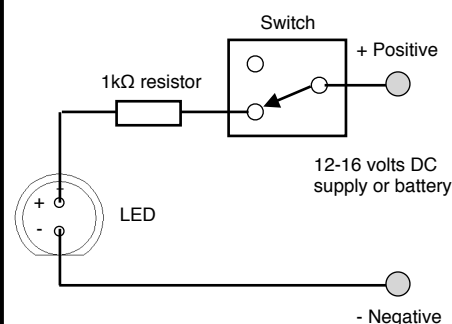

General information on LEDs

LEDs are really useful lights which, unlike their conventional filament bulb counterparts, are robust, low power and if used correctly can effectively last forever. But there are important considerations to using them.

LED stands for *Light Emitting Diode* and a diode is an electronic component which only works electrically in one direction, so always need to be fitted the correct way round to work correctly and last. Whilst LED's will work on AC (alternating current or DCC which is a form of AC) for a while, continuous use on AC or reverse connection will reduce the life.

Most standard miniature LEDs which a modeller will use must only have a maximum voltage of 2 to 3 volts applied, so current flowing through the LED needs to be reduced and this is usually done by a resistor in series (in between), typically 1000 ohms for a 12 V supply. However to make wiring easier for modellers all Train-Tech LFX and Signal LED controllers already have resistors built in so that LEDs can connect directly to the module without the need for any resistors.

Train-Tech also offer packs of various LEDs for modellers and these always come with instructions and also suitable resistors for using them on a standard Model Railway 12V DC supply.

LED connections

As explained previously most LEDs have a polarity and must be connected the correct way round to light. The most popular LEDs come in 3mm and 5mm diameter cases and look similar to this:

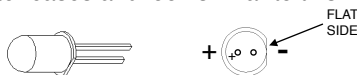

The best indication of polarity on this type of LED is to find the flat side on the round base. This side usually indicates the negative (Cathode) connection and the other wire the positive (Anode) connection to power.

Another very small LED we supply for some Train-Tech products looks like this:



There are many LEDs on the market and it is good to experiment, but check manufacturers data for specific connection information as there are no real standards.

Remember to always use a resistor in series with the LED when using it on a standard DC power supply or battery.

Resistors

We offer the following for interest only - a modeller does not usually have to know what a component does, just when to use it. Resistors are probably the most commonly used electronic component. They offer a resistance to flow of current in a circuit by converting the 'resisted' energy into heat, though in practice you will not usually be able to detect the heat dissipated because of the small amounts of power usually involved. Every resistor has a resistance value measured in ohms, often shown as Ω or sometimes R. The resistors supplied with our LEDs are 1K Ω ; 1 kilo ohm or 1000 ohms. There are many different values of resistor and most are colour coded to indicate their value. For interest, this is the colour code system in case you ever need to identify one:

| | | | |
|--------|---|--------|---|
| Black | 0 | Green | 5 |
| Brown | 1 | Blue | 6 |
| Red | 2 | Violet | 7 |
| Orange | 3 | Grey | 8 |
| Yellow | 4 | White | 9 |

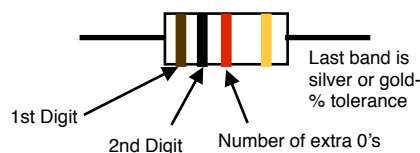

So a 1000 Ω (1k Ω) resistor is colour coded: Brown = 1; Black = 0; Red = 0 0